

Fire Pits, Screens, Grates and Accessories WARRANTY

Original Owner Warranty:

Aspen Industries, Inc. warrants its Fire Pits, Safety Screens, Fire Grates, Fire Pit Covers and Accessories, **to the original owner**, against breakage (except breakage due to mishandling and abuse) for 12 months from the date of consumer purchase. No warranty on paint – normal weathering and some discoloration may occur depending upon materials burned. Scratched or exposed metal will oxidize and discolor. Shipping not included.

Our Return Policy covers damaged or defective products only. Scratched or exposed metal will oxidize and discolor. If you feel that your product is defective or has been damaged during shipment, please contact one of our Customer Service representatives immediately at sales@masterflame1.com.

If the product is found to be defective or damaged, either a replacement or refund may be issued. Any refund issued will be applied to you as credit in your account. If the product was damaged during shipment, we will require for you to provide us with information and pictures of the damaged product including packaging so that we may file a claim with our shipper.

Gas Log and Burner WARRANTY

Original Owner Warranty:

Aspen Industries, Inc. warrants its Gas Burner Assemblies, **to the original registered owner**, against breakage (except breakage due to mishandling and abuse) for life. Aspen Industries, Inc. warrants its factory installed pilot valves, controls, accessories and logset to its owner, against any performance defects for a period of 1 year from the date of consumer purchase. Shipping not included. WARRANTY REGISTRATION IS REQUIRED.

Aspen Industries, Inc.
Master Flame Products
Bensenville, IL 60106
Voice: 630-238-0611
Toll Free: 800-642-7254
Fax: 630-238-9871
sales@masterflame1.com



TERMS & CONDITIONS

PAYMENT TERMS:

1% 10, NET 30 DAYS. Late charges 2% per month on payments beyond terms.

FREIGHT:

F.O.B. Bensenville, IL60106

LEADTIME

Your order will ship in 10-14 business days from receipt of order.

CREDIT CARDS:

Aspen Industries, Inc. accepts Visa and Mastercard for Invoice payments (2% added to credit card processing transaction).

RETURNS:

A Returned Goods Authorization (RGA) is required prior to return of material. There is a 20% restocking fee for all returned goods. Return shipping not included.

DAMAGED FREIGHT

Upon inspection of delivered products, if the package was delivered via FedEx ground or UPS ground, email us at sales@masterflame1.com when you notice any damages and we'll reship a new product and take care of all claims. If the product comes on a skid / pallet via common carrier (LTL) such as an extremely large fire pit screen. Inspect the product before signing any paperwork. Upon inspection, if you notice damages then refuse the freight and call us and we'll reship you a new product. All of our products have stickers on the package. Do not accept if product is damaged. This is very important. Once you sign the paper work you are saying that you received the product in good shape and there are no damages. In the unfortunate event that a product is delivered and you do sign for it without inspecting the product first – then according to the freight companies' policies all damage claims must be filed by the consignee (the receiving customer) If you have any questions, please call 630.238.0611. It's best that you completely understand this before ordering and freight being delivered via Common LTL carriers. If you arrange for your freight company to pick up any product from our warehouse, we will not accept liability for any damages. This would be between you and whomever picked up the freight from our warehouse. This includes any freight forwarding companies as well.

PRICE POLICY: All prices are subject to change without notice. Orders are subject to credit approval at time of placement.

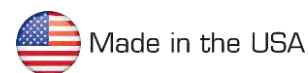

Authorized Dealers are listed on
our website:
www.masterflamegaslogs.com

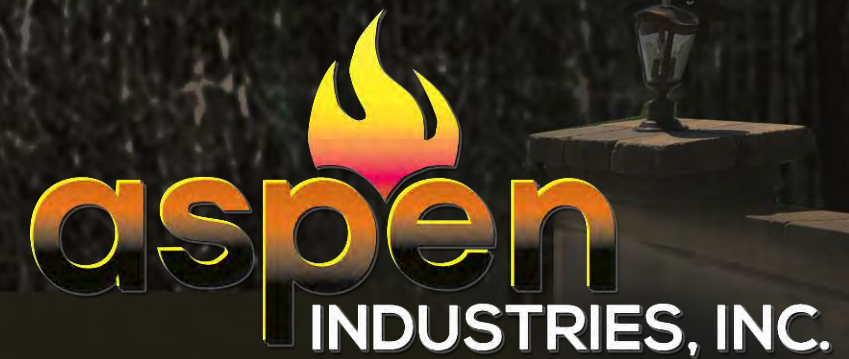

**Master Flame® Fire Pit Screens, Fire Grates,
All-Steel Fire Pits, Gas Logs and Burner Sets**



Made in the USA

800-642-7254

Master Flame™ Outdoor Fire Pit Safety Screens

Spark Arresting 8 x 8 per inch
23 Gauge Steel Wire Mesh

Lift Off Dome

Single Hinged Access
Panel Option Available

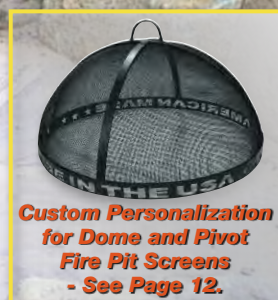

Twin Access Panels

LIFT OFF DOME FIRE PIT SCREEN

TWIN ACCESS FIRE PIT SCREEN

Master Flame™ Fire Pit Safety Screen

Helps prevent accidents, contains incendiary sparks, ash and soot. Lift off screen to tend fire (poker required when hot).

- Available in welded carbon steel, stainless steel or hybrid
- 1/4" x 1" solid steel flat bar framework
- Steel mesh screen (8 x 8 per/sq. inch; 23 gauge steel wire; 64 openings/sq. inch)
- High heat-resistant electrostatically applied, weather-resistant black finish
- Welded handles top and front; extra handle - \$10 UPCHARGE

Dome-Shaped Fire Pit Screen (Poker Required)

NOTE: Screen Height is approximately 17" unless specified.



Stainless Steel Lift Off Dome with Brushed Finish



Round Dome Fire Pit Screen Sizing:

- Height is approximately 17"
- **OVER 60"**: Use per inch adder and add to 60" MSRP.

Add Stop Tabs for Fire Bowl Pivot Screen Installation

- 4 Stop Tabs welded to inside of screen

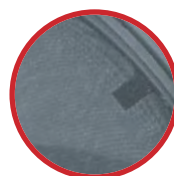

LIFT OFF DOME

Safety Screen LIFT OFF DOME	24" THRU 29" MSRP	30" THRU 35" MSRP	36" THRU 41" MSRP	42" THRU 47" MSRP	48" THRU 52" MSRP	53" THRU 60" MSRP	OVER 60" per inch ADDER Add to 60" MSRP
CS*	\$369	\$445	\$497	\$536	\$617	\$968	\$44
HYBRID*	\$404	\$477	\$574	\$636	\$719	\$1129	\$66
304 SS*	\$598	\$713	\$752	\$780	\$860	\$1385	\$88

* Refer to chart on page 6.

How to determine screen size to order from Master Flame Dealer

- For Round: Measure pit inside diameter and add 4".

Brushed Finish Available for Stainless Steel Models - \$75 UPCHARGE
Single Door Hinged Access Option - \$175 UPCHARGE

Approximate Unit Weight: 1lbs per inch of diameter
(Example 42" Diameter Screen weighs about 42 lbs.)

Master Flame™ Fire Pit Safety Screen

Helps prevent accidents, contains incendiary sparks, ash and soot. Two hinged doors (panels with decorative handle) allow access and simple fire management.

- Available in welded carbon steel, stainless steel or hybrid
- 1/4" x 1" solid steel flat bar framework
- Steel mesh screen (8 x 8 per/sq. inch; 23 gauge steel wire; 64 openings/sq. inch)
- Stainless steel hardware
- High heat-resistant electrostatically applied, weather-resistant black finish

1/4" x 1" Bar

No Custom Personalization on Hinged Fire Pit Screens

NOTE: Screen Height is approximately 17" unless specified.



Both Hinged Access Doors Open

Round Hinged Fire Pit Screen Sizing:

- Height is approximately 17" unless specified
- Over 40" diameter includes reinforced bracing strap on bottom rail
- **OVER 60"**: Use per inch adder and add to 60" MSRP.
- Custom mounting tabs available – CALL FOR QUOTE.



HINGED ROUND

Safety Screen HINGED ROUND (TWIN DOORS)	24" THRU 29" MSRP	30" THRU 35" MSRP	36" THRU 41" MSRP	42" THRU 47" MSRP	48" THRU 52" MSRP	53" THRU 60" MSRP	OVER 60" per inch ADDER Add to 60" MSRP
CS*	\$752	\$932	\$958	\$998	\$1044	\$1367	\$44
HYBRID*	\$793	\$958	\$1022	\$1084	\$1157	\$1535	\$66
304 SS*	\$1031	\$1249	\$1276	\$1322	\$1372	\$1865	\$88

* Refer to chart on page 6.

How to determine screen size to order from Master Flame Dealer

- For Round: Measure pit inside diameter and add 4".

Brushed Finish Available for Stainless Steel Models - \$75 UPCHARGE

Approximate Unit Weight: 1lb. per inch of diameter
(Example 42" Diameter Screen weighs about 42 lbs.)

Master Flame™ Outdoor Fire Pit Safety Screens

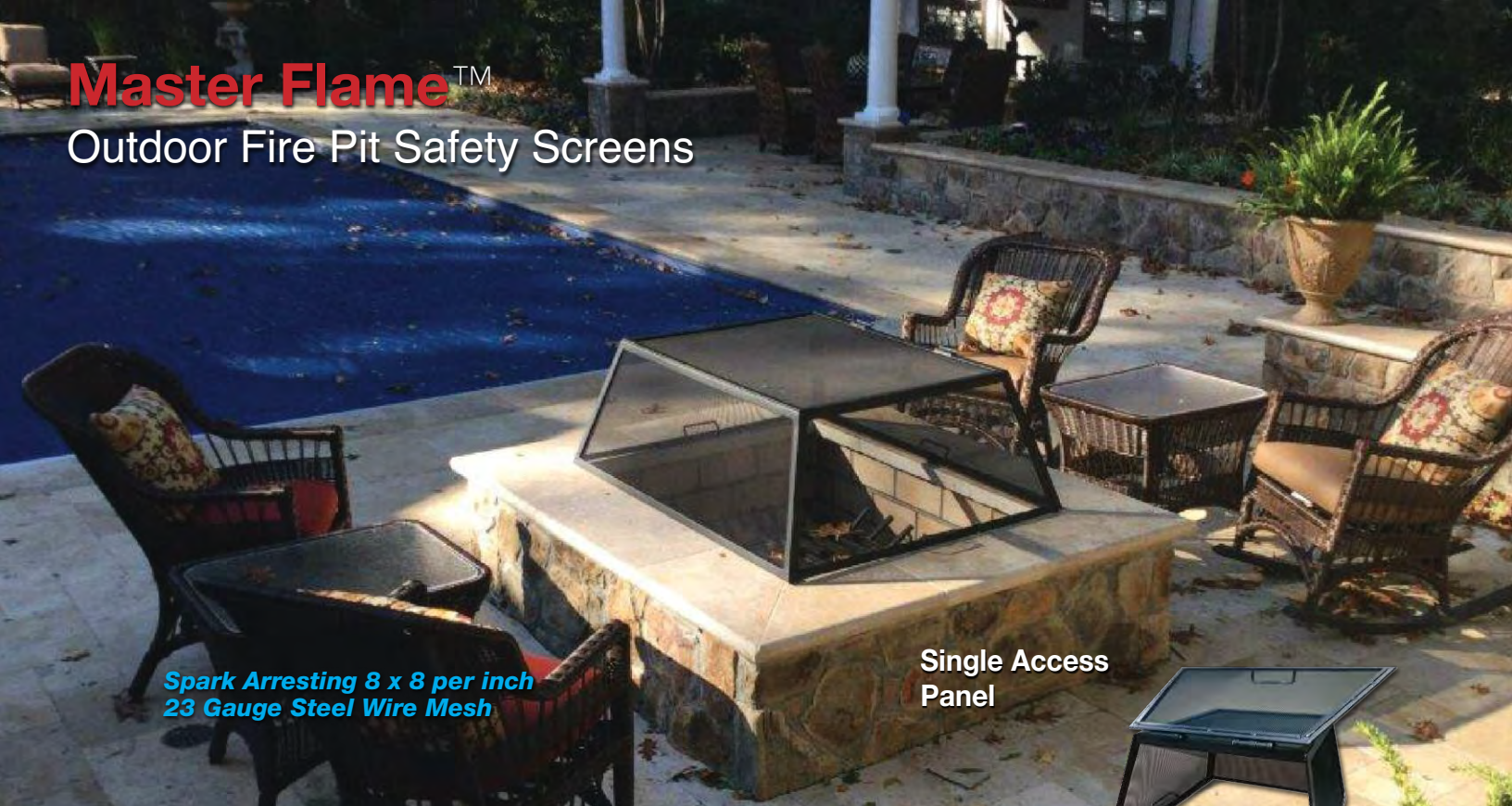

Spark Arresting 8 x 8 per inch
23 Gauge Steel Wire Mesh

Single Access
Panel

Single Access
Panel

SINGLE ACCESS FIRE PIT SCREEN

SINGLE ACCESS FIRE PIT SCREEN

Master Flame™ Square / Rectangular Fire Pit Safety Screen

Helps prevent accidents, contains incendiary sparks, ash and soot. Hinged front door (panel with handle) opens up for access and simple fire management.

- Available in welded carbon steel, stainless steel or hybrid
- 1/4" x 1" solid steel flat bar framework
- Steel mesh screen (8 x 8 per/sq. inch; 23 gauge steel wire; 64 openings/sq. inch)
- Stainless steel hardware
- High heat-resistant electrostatically applied, weather-resistant black finish

Square / Rectangular Fire Pit Screen Sizing: TOTAL PERIMETER (Length + Width x 2)

- Two handles on bottom sides and one handle on door
- Height is 17" unless specified to be lower;
- For height over 17", CALL FOR QUOTE
- Over 192" Perimeter, use per inch adder and add to 192" MSRP.
- Custom mounting tabs available, CALL FOR QUOTE.



Hinged Rectangle Model

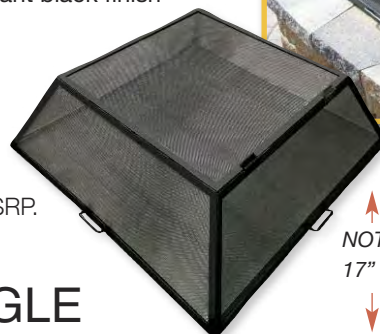

NOTE: Screen Height is approximately 17" unless specified.

HINGED SQUARE / RECTANGLE

Safety Screen HINGED (SINGLE DOOR)	17" Height TOTAL PERIMETER Up to 120" MSRP	17" Height TOTAL PERIMETER From 121 up to 144" MSRP	17" Height TOTAL PERIMETER From 145 to 192" MSRP	TOTAL PERIMETER 192"+ per inch ADDER Add to 192" MSRP
CS*	\$932	\$1047	\$1198	\$44
HYBRID*	\$998	\$1166	\$1385	\$66
304 SS*	\$1249	\$1341	\$1559	\$88

* Refer to chart on page 6.

Example: Carbon Steel 30" x 30" hinged square = \$932, 304 SS 45" x 45" hinged square = \$1559, Hybrid 32" x 50" hinged rectangle = \$1385

How to determine screen size to order from Master Flame Dealer

- For Square/Rectangle: Add 4" to inside pit dimensions (4" to length and 4" to width).

Approximate Unit Weight: 1lb. per inch of diameter (42" Diameter Screen weighs about 42 lbs.)

NEW LOW PROFILE Square Fire Pit Screen

Master Flame™ Low Profile Square Fire Pit Safety Screen

Helps prevent accidents, contains incendiary sparks, ash and soot. Hinged front door (panel with handle) opens up for access and simple fire management.

- Available in welded carbon steel, stainless steel or hybrid
- 1/4" x 1" solid steel flat bar framework
- Steel mesh screen (8 x 8 per/sq. inch; 23 gauge steel wire; 64 openings/sq. inch)
- Stainless steel hardware
- High heat-resistant electrostatically applied, weather-resistant black finish

Square / Rectangular Fire Pit Screen Sizing: TOTAL PERIMETER (Length + Width x 2)

- Handle on top and handle on door
- Height is 12"; for change in height, CALL FOR QUOTE.
- Over 192" Perimeter, use per inch adder and add to 192" MSRP.
- Custom mounting tabs available, CALL FOR QUOTE.

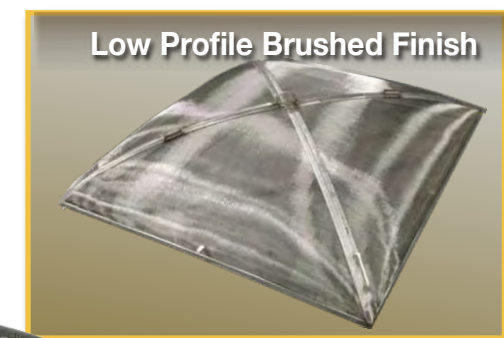

Low Profile Brushed Finish



NOTE: Screen Height is approximately 12" unless specified.

LOW PROFILE HINGED SQUARE / RECTANGLE

Safety Screen HINGED (SINGLE DOOR)	12" Height TOTAL PERIMETER Up to 120" MSRP	12" Height TOTAL PERIMETER From 121 up to 144" MSRP	12" Height TOTAL PERIMETER From 145 to 192" MSRP	TOTAL PERIMETER 192"+ per inch ADDER Add to 192" MSRP
CS*	\$932	\$1047	\$1198	\$44
HYBRID*	\$998	\$1166	\$1385	\$66
304 SS*	\$1249	\$1341	\$1559	\$88

* Refer to chart on page 6.

Brushed Finish Available for Stainless Steel Models
- \$75 UPCHARGE

How to determine screen size to order from Master Flame Dealer

- For Square Screen: Add 4" to inside pit dimensions (4" to length and 4" to width).

Example: Carbon Steel 30" x 30" hinged square = \$932, 304 SS 45" x 45" hinged square = \$1559, Hybrid 50" x 50" hinged square = \$1913

Approximate Unit Weight: 1lb. per inch of diameter (42" Diameter Screen weighs about 42 lbs.)

Master Flame™ Outdoor Fire Pit Safety Screens



Spark Arresting 8 x 8 per inch
23 Gauge Steel Wire Mesh

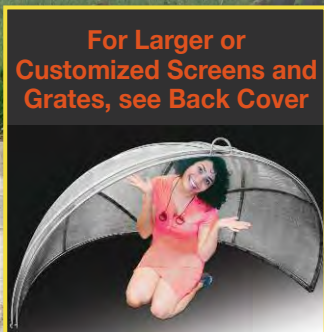

PIVOT ACCESS FIRE PIT SCREEN

Master Flame™ Fire Pit Safety Screen

Helps prevent accidents, contains incendiary sparks, ash and soot. Open either side of the clamshell styled pivot screen for access and simple fire management.

- Available in welded carbon steel, stainless steel or hybrid
- 1/4" x 1" solid steel flat bar framework
- Steel mesh screen (8 x 8 per/sq. inch; 23 gauge steel wire; 64 openings/sq. inch)
- Stainless steel hardware
- High heat-resistant electrostatically applied, weather-resistant black finish

1/4" x 1" Bar

IMPORTANT: Screen size is equal to inside diameter; the larger side of the pivot has a 1" larger diameter (figure at right).

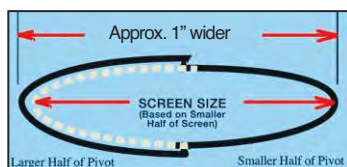

Pivot Screen Right Side Open

Pivot Screen Left Side Open

NOTE: Screen Height is equal to 1/2 the diameter.

PIVOT ROUND

Safety Screen PIVOT ROUND	24" THRU 29" MSRP	30" THRU 35" MSRP	36" THRU 41" MSRP	42" THRU 47" MSRP	48" THRU 52" MSRP	53" THRU 60" MSRP	OVER 60" per inch ADDER Add to 60" MSRP
CS*	\$396	\$474	\$562	\$607	\$787	\$1154	\$44
HYBRID*	\$442	\$535	\$673	\$734	\$931	\$1363	\$66
304 SS*	\$639	\$767	\$865	\$898	\$1100	\$1653	\$88

* Refer to chart on page 6.

Brushed Finish Available for Stainless Steel Models - \$75 UPCHARGE

Approximate Unit Weight: 1lbs per inch of diameter (Example 42" Diameter Screen weighs about 42 lbs.)

How to determine screen size to order from Master Flame Dealer

- For Round: Measure pit inside diameter and add 4".

Round Pivot Fire Pit Screen Sizing:

- Height is proportional (1/2 of diameter).
- All screens up to 47" diameter are 4 panel.
- All screens 48" diameter and over are 8 panel.
- **OVER 60"**: Use per inch adder and add to 60" MSRP.
- Custom mounting tabs available, CALL FOR QUOTE.

Custom Mounting Clamps and Tabs available for Fire Bowl Fire Pits - \$25 UPCHARGE.



Add Clamps and Stop Tabs for Fire Bowl Pivot Screen Installation

- Bowl Clamps welded to screen
- 2 Stop Tabs welded to inside of screen



Clamps and Stops for Mounting Pivot Screen to Fire Pit Bowl - \$25 UPCHARGE.

STANDARD BLACK FINISH OPTIONAL STAINLESS STEEL OPTIONAL HYBRID STANDARD CARBON STEEL

Framework	304 Stainless	Carbon Steel	Carbon Steel
Mesh	Stainless Steel	Stainless Steel	Carbon Steel
Hardware	Stainless Steel	Stainless Steel	Stainless Steel



WELDED STEEL FIRE PIT GRATES

Master Flame™ Round Fire Pit Grate

Round grate shape is ideal for campfires, fire pits or corner wood-burning fireplaces. Master Flame grates are a great update for old cast iron grates.

- Choice of welded 5/8" carbon steel bar stock or stainless steel bar stock
- Standard Sizes - *Tip to Tip (Tine)*: 38", 36", 33", 30", 27", 24"
- 4" standard leg height for optimal burn; 4" standard tine height (8" floor to top of tine)
- Optional Char-Guard Ember Catch

Round Fire Grate

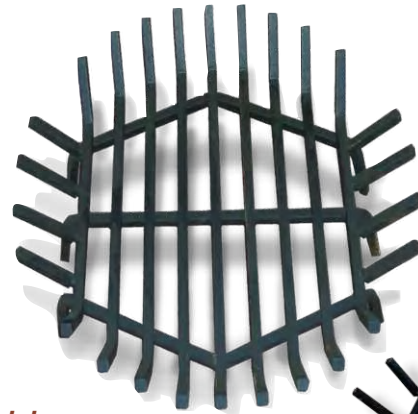

5/8"
Bar

Round Fire Grate with Char-Guard Ember Catch



Char-Guard Models

Char-Guard Option improves complete burn consistency, simplifies ash clean-up and allows you the choice of using charcoal. Char-Guard is heavy duty expanded metal fitted and welded to the underside of the grate.

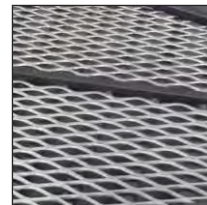

How to determine grate size to order:
For Round Grates, order at least 6" smaller diameter than the inside fire pit dimensions for 3" space all around.



ROUND GRATES

FIRE PIT GRATE ROUND	24" MSRP	27" MSRP	30" MSRP	33" MSRP	36" MSRP	38" MSRP	Over 38" per inch ADDER to 38" MSRP
5/8" CARBON STEEL	\$265	\$285	\$299	\$343	\$438	\$550	\$15
5/8" STAINLESS STEEL	\$765	\$813	\$964	\$1035	\$1100	\$1170	\$30
Approx. Weight of Grate:	43 lbs	54 lbs	64 lbs	70 lbs	77 lbs	82 lbs	
CHAR-GUARD Ember Catch Option	24" Grate Adder to MSRP	27" Grate Adder to MSRP	30" Grate Adder to MSRP	33" Grate Adder to MSRP	36" Grate Adder to MSRP	38" Grate Adder to MSRP	Over 38" Adder to MSRP
	\$45	\$52	\$65	\$83	\$125	\$125	\$125

Longer or shorter legs available - \$10 UPCHARGE

TeePee FIRE GRATE

The TeePee Grate allows kindling or firewood to be leaned up against itself in a tepee shaped cone or pyramid. As the wood burns and falls into the middle it will create a "core of heat" of hot wood embers.

- Welded 5/8" carbon steel bar stock
- 17" Tall (Top to bottom)

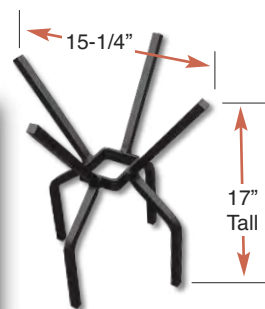

TEEPEE GRATE	MSRP
5/8" Carbon Steel	About 15 lbs \$105

Master Flame™ Square Fire Pit Grate

For square fire pits, these fire grates are weld steel bar design. Master Flame grates are a great update for old cast iron grates.

- Choice of welded 5/8" carbon steel bar stock or stainless steel bar stock
- Square Sizes - 24" x 24", 27" x 27", 30" x 30", 36" x 36", 38" x 38"
- 4" legs for optimal air circulation (longer or shorter legs available for \$10 UPCHARGE)
- Optional Char-Guard Ember Catch

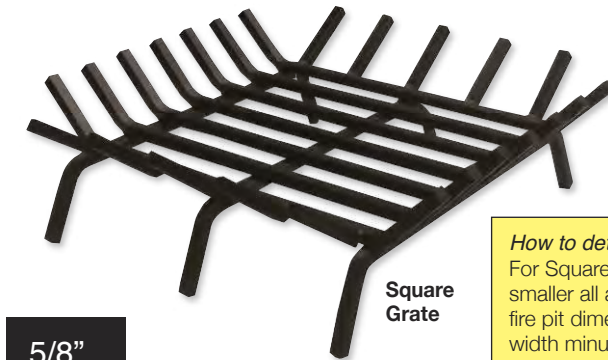

5/8"
Bar

Square Grate

How to determine grate size to order:
For Square Grates, order at least 3" smaller all around than the inside fire pit dimensions (length minus 6" and width minus 6").



Square Fire Grate with Char-Guard Ember Catch

Char-Guard Models

Char-Guard Option improves complete burn consistency, simplifies ash clean-up and allows you the choice of using charcoal. Char-Guard is heavy duty expanded metal fitted and welded to the underside of the grate.

SQUARE GRATES

FIRE PIT GRATE SQUARE	24"x24" MSRP	27"x27" MSRP	30"x30" MSRP	33"x33" MSRP	36"x36" MSRP	38"x38" MSRP	Over 38" per inch ADDER to 38" MSRP
5/8" CARBON STEEL	\$292	\$314	\$329	\$377	\$460	\$578	\$15
5/8" STAINLESS STEEL	\$775	\$825	\$985	\$1171	\$1210	\$1250	\$30
CHAR-GUARD Ember Catch Option	24" Grate Adder to MSRP	27" Grate Adder to MSRP	30" Grate Adder to MSRP	33" Grate Adder to MSRP	36" Grate Adder to MSRP	38" Grate Adder to MSRP	Over 38" Adder to MSRP
	\$45	\$52	\$65	\$83	\$125	\$125	\$125

Longer or shorter legs available - \$10 UPCHARGE

POKER

3/8"
Dia.

with HOOK-BACK Tip

Stainless Steel Pokers (40" Long)

- Welded 304-Stainless steel rod, 3/8" diameter
- Vinyl foam handle (Closed Cell)
- Hook-back tip
- Custom Lengths Available

STAINLESS STEEL POKER	3/8" DIA. STAINLESS STEEL 40" LENGTH WITH CLOSED CELL VINYL HANDLE	DISPLAY STAND	MSRP
Hook Back Design	MSRP \$55	Holds 10 Pokers	\$100
		Display ONLY	FREE
		Purchase 10 Poker	FREE

Weight of poker - 3 lbs. each

POKER Display Stand

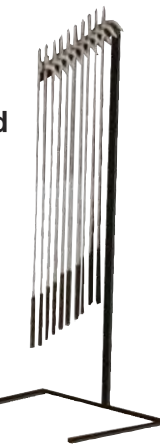

FIRE PIT COVERS and SNUFFERS

FIRE PIT SNUFFERS - Optional Monogram

DOME COVER

42" Diameter and 12" High
30" and 36" Diameter and 8" High



Dome Fire Pit Cover helps snuff out the fire in a shorter period of time and keeps debris and rain out of your fire pit.

- Spun Carbon Steel, 14 Gauge
- 42" Diameter Size covers fire pits up to 40" diameter; 12" dome height
- 36" Diameter Size covers fire pits up to 34" diameter; 8" dome height
- 30" Diameter Size covers fire pits up to 28" diameter; 8" dome height
- Edge Trim
- High heat-resistant electrostatically applied, weather-resistant black finish on topside

Welded Top and Side Stainless Steel Handles



DOME FIRE PIT COVER	30" Dia. MSRP	36" Dia. MSRP	42" Dia. MSRP
CARBON STEEL	\$555	\$580	\$640
Approximate Weight	40 lbs.	42 lbs.	45 lbs.

Heat and weather-resistant black paint to underside - \$20 UPCHARGE

ROUND or SQUARE

FOLDING Fire Pit Cover



Round and Square Pit Cover helps snuff out the fire in a shorter period of time and keeps debris and rain out of your fire pit.

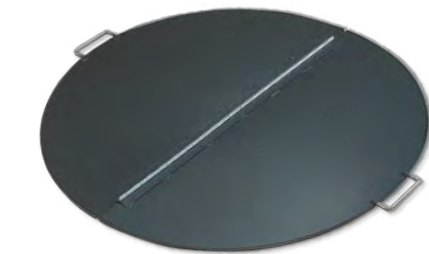

Welded Stainless Steel Handles and Hinge Knuckle Not Painted

- #304 Stainless Steel, 16 Gauge
- Edge Trim
- High heat-resistant electrostatically applied, weather-resistant black finish on *topside*

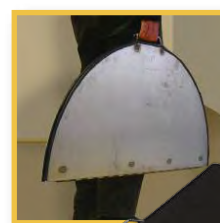

Folds in Half for Easy Storage

How to determine cover size to order: Order at least 2" larger all around than the inside fire pit dimensions (pit interior diameter plus 4"; or pit inside length plus 4" and width plus 4").

FOLDING FIRE PIT COVER	20" THRU 31" MSRP	32" THRU 48" MSRP	49" THRU 69" MSRP	OVER 69" MSRP
STAINLESS STEEL	\$562	\$667	\$989	CALL FOR QUOTE

Heat and weather-resistant black paint to underside - \$20 UPCHARGE

Approximate Unit Weight: 0.90 lbs per inch of diameter
(Examples: 48" Folding Pit Cover weighs about 43.2 lbs; 44" cover weight is about 39.6 lbs; 32" Cover weighs about 28.8 lbs.)

OCTAGONAL, ROUND or SQUARE

Fire Pit Cover - Snuffer Lid



Optional Custom MONOGRAM Available (Requires 2nd handle)



One Welded Stainless Steel Handle (Not Painted), 2nd Handle available

These Snuffer Lids helps put out the fire in a shorter period of time and not only keeps outside debris from getting into your fire pit...it keeps the unburned wood dry for the next time you build a fire.

- 18 Gauge Galvanized Metal Plated Finish
- High heat-resistant electrostatically applied, weather-resistant black finish
- Welded stainless steel handle
- Edge Trim
- All monograms (Book Antigua Type) made of stainless steel

How to determine cover size to order: Order at least 2" larger all around than the inside fire pit dimensions (pit interior diameter plus 4"; or pit inside length plus 4" and width plus 4").

Octagonal / Round / Square SNUFFER LID	20" THRU 24" MSRP	25" THRU 33" MSRP	34" THRU 38" MSRP	39" THRU 44" MSRP	45" THRU 48" MSRP
Galvanized Steel Plated	\$261	\$294	\$317	\$360	\$380
STAINLESS STEEL	\$449	\$480	\$549	\$560	\$585
MONOGRAM* Black Finish	\$70 Upcharge	\$70 Upcharge	\$70 Upcharge	\$70 Upcharge	\$70 Upcharge
MONOGRAM* Unpainted	\$70 Upcharge	\$70 Upcharge	\$70 Upcharge	\$70 Upcharge	\$70 Upcharge
Round / Square with Hi-Rim SNUFFER Cover	20" THRU 24" MSRP STAINLESS STEEL ONLY	25" THRU 33" MSRP STAINLESS STEEL ONLY	34" THRU 38" MSRP STAINLESS STEEL ONLY	39" THRU 44" MSRP STAINLESS STEEL ONLY	NOT AVAILABLE
3" Height Adder Available on ROUND or SQUARE Stainless Steel Snuffers only	\$150	\$175	\$200	\$250	NA

Heat and weather-resistant black paint to underside - \$20 UPCHARGE

Extra Handle - \$10 UPCHARGE

Monogram - \$70 UPCHARGE

Hi-Rim Over 3" Height - CALL FOR QUOTE

Approximate Unit Weight Galvanized Steel Covers: 0.45 lbs per inch of diameter

Approximate Unit Weight Stainless Steel Covers: 0.90 lbs per inch of diameter

(Examples: 48" Galvanized Steel Cover weighs about 21.6 lbs; 44" Galvanized Steel Cover weight is about 19.8 lbs; 32" Stainless Steel Cover weighs about 28.8 lbs.)

Master Flame™

Welded Steel Outdoor Fire Pits



Fire Pit Screen CUSTOM Personalization



ROUND BOWL FIRE PITS

Master Flame™ Fire Bowl Fire Pit

Steel round bowl fire pits are available in 24" diameter, 30" diameter and 36" diameter with a choice from seven base styles. Drained bowl design includes steel grate. Optional pivot or dome fire pit safety screen is available in mild steel, hybrid or all stainless steel models.

Welded Steel Fire Pit Grate

- Welded 5/8" steel bar stock
- Heat and weather-resistant black finish

Welded Steel Fire Pit

- 9 gauge carbon steel bowl
- Welded metal mesh welded to center drain
- 30" bowl approximately 18" fire pit height; 36" bowl approximately 20" height (17" screen height)
- Heat and weather-resistant black finish

OPTIONAL Dome or Pivot Model Fire Pit Safety Screen

- Screen height: Dome is approx. 17"
- Pivot Model is approximately half the diameter of bowl
- 1/4 x 1" solid welded steel framework
- Steel wire screen mesh (8 x 8 per/sq.inch; 23 gauge)
- Choice of carbon steel, hybrid or all stainless steel

TRIPOD Base (TRIPOD)



FOUR LEG BASE-ROUND (4LG-R)



FOUR LEG BASE-SQUARE (4LG-S)



FOUR LEG BASE-SQUARE (4LG-SQ)



Standard X BASE (XBASE)



Drained Bowl Design



Round Fire Pit Bowl and grate shown with PERSONALIZED (page 12) Pivot Model Fire Pit Safety Screen

BLACK SWAN BASE (SWN)



RING BASE (RING)



36" Fire Pit Bowl and grate shown with 4 Leg Square Base and with Dome Fire Pit Safety Screen

LIFT OFF DOME and PIVOT STYLE Fire Pits Screens ONLY

CUSTOM Personalization

for Round DOME STYLE and PIVOT STYLE Fire Pit Screens

Your name, theme or message will be plasmacut into the lower frame before fabrication. The 1-1/4" tall block type lettering (ARIEL BOLD) is stencilized so it can be cut into 1/8" x 2" steel bar stock for fabricating the lower rim on fire pit safety screen's framework.

MASTER FLAME Round Pivot Safety Screens: Message and words must fit between pivot points with 3" clearance. Lettering can be cut into both halves of Pivot Screen lower frame rims. (Dependent on size – see common screen diameters in chart.)

MASTER FLAME Round Lift Off Dome Safety Screens: Message and words must fit on the rim. Lettering can go all the way around a Lift Off Dome Screen. (Dependent on size – see common screen diameters in chart.)

PERSONALIZATION MINIMUM CHARGE:
\$210 US Dollars for up to 30 Letters
Additional letters - \$7 per letter

ROUND or PIVOT FIRE PIT SCREEN SIZE	Approximate Number of Characters Front Half Rim	Approximate Number of Characters Back Half Rim
NOTE: Spaces between words count as characters.		
24" Diameter	15 letters including spaces	15 letters including spaces
30" Diameter	20 including spaces	20 including spaces
36" Diameter	25 including spaces	25 including spaces
42" Diameter	29 including spaces	29 including spaces
48" Diameter	34 including spaces	34 including spaces
60" Diameter	44 including spaces	44 including spaces
2023 MSRP PERSONALIZATION Charge	Up to 30 letters: \$210	\$7.00 per Letter Adder after 30 letters

Notes: For personalization, the lower 1" rim framework will be replaced by a 2" piece of framework. Characters are plasmacut into **the bottom frame rim** (refer to chart). Dome and Pivot Screens for Round Fire Bowls will have STOP Tabs and Mounting Clamps welded to Fire Pit Screens to attach to the bowl.

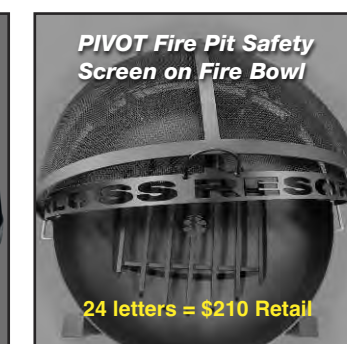

For fire bowl screens, STOP Tabs welded inside rim for improved fit. Mounting Clamps welded to Fire Pit Screens to attach to bowl.



Please email lettering information to : sales@masterflame1.com.

Master Flame™

Welded Steel
Outdoor Fire Pits



SQUARE OR RECTANGULAR FIRE PITS

Master Flame™ Square or Rectangular Fire Pit



36" x 36" Square Steel Fire Pit with Grate and Standard Metal Plate Base

Example Weight (36" x 36" square fire pit shown above): Approximately 266 lbs. (Fire Pit Screen is approximately 56 lbs.; Grate 50 lbs.; and Fire Pit alone 160 lbs.)

Enjoy the warmth, mood and glow of an outdoor fire in your gathering area. This durable and lasting fire pit design comes with steel fire grate and optional hinged fire pit safety screen for simple fire management. Available in 5 sizes.

Welded Steel Fire Pit

- 9 gauge steel plate
- smaller footprint
- 20" Fire Pit Height (37" Height with safety screen)
- Heat and weather-resistant black finish

Welded Steel Square Fire Pit Grate

- 5/8" steel bar stock
- 2" legs
- Heat and weather-resistant black finish

OPTIONAL Hinged Fire Pit Safety Screen

- Fitted square or rectangular model
- Screen height is approximately 17"
- 1/4 x 1" solid welded steel framework
- Steel wire screen mesh (8 x 8 per/sq.inch; 23 gauge)
- Choice of carbon steel, hybrid or all stainless steel

Square or Rectangle Fire Pit	BASE CHOICE	MSRP Fire Pit (Drop-in Drink Rail not included)	HINGED Safety Screen Adder
24" x 24"	STANDARD or CUSTOM	\$888	\$932 Carbon Steel \$998 Hybrid \$1249 Stainless
30" x 30"	STANDARD or CUSTOM	\$1013	\$932 Carbon Steel \$998 Hybrid \$1249 Stainless
36" x 36"	STANDARD or CUSTOM	\$1422	\$1047 Carbon Steel \$1166 Hybrid \$1341 Stainless
36" x 30"	STANDARD or CUSTOM	\$1104	\$1047 Carbon Steel \$1166 Hybrid \$1341 Stainless
30" x 24"	STANDARD or CUSTOM	\$995	\$932 Carbon Steel \$998 Hybrid \$1249 Stainless

Customization: Steel fire pit can be customize by plasma cutting the steel plate base, side panels or painting artwork on metal plate or ember screen. Plasmacut artwork is limited to silhouette cutting or stenciled logo.



For Customization, CALL FOR QUOTE. Art plasma-cut into fire pit base us available on all 4 sides.

Fully Vented Specialty Burner



INDOOR SPECIALTY BURNER

ROYAL SERIES COAL EFFECT PAN BURNER

FITS MOST Basket Designs



- 12" Front X 6-3/4" Rear X 6" Deep Tray
- 14" Front X 8-3/4" Rear X 6" Deep Tray
- Burner supplied with dispersion medium (non-burning)
- 30-piece coal set (glowing non-consumables for pan)



Model GV34
MMV/HHR
Shown



Hi Lo Modulating
MMV/HHR
MERTIK GV34 - Hi Lo

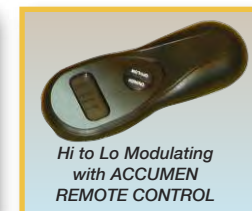

Hi to Lo Modulating
with ACCUMEN
REMOTE CONTROL



Hi to Lo
Modulating
with
Electronic
Ignition and
REMOTE
CONTROL

ROYAL SERIES Coal Effect Burner	MODEL	WITH MMV-READY MSRP	WITH MMV/HHR MSRP	WITH EIR MSRP
#B 401 12 NG	12" Burner - NG	\$713	\$864	\$972
#B 401 12 LP	12" Coal - LP			
#B 401 14 NG	14" Burner - NG			
#B 401 14 LP	14" Burner - LP			
ACCESSORY	DESCRIPTION	MSRP		
#COAL B	Bag of COAL (Non-Burning): Enough to Fill 14" Burner Tray	\$40.00		

SAME PRICING FOR ALL MODELS!

BURNER SUPPLIED WITH COAL (Non-Burning Synthetic)

Master Flame™

Indoor Fully Vented Gas Log Fireplace Systems



GAS LOG BURNERS

ELITE TRIPLE BURNER with LOGS



Red Oak Logs (RO)

The Master Flame Elite TRIPLE BURNER design feature MASTER FLAME's SANDLESS STRAIGHT PORT INJECTION SYSTEM and rear-elevated back log supports for a brighter, fuller flame and the most natural wood-burning look.



Charred Split Oak Logs (CSO)



Aged Oak Logs (AO)

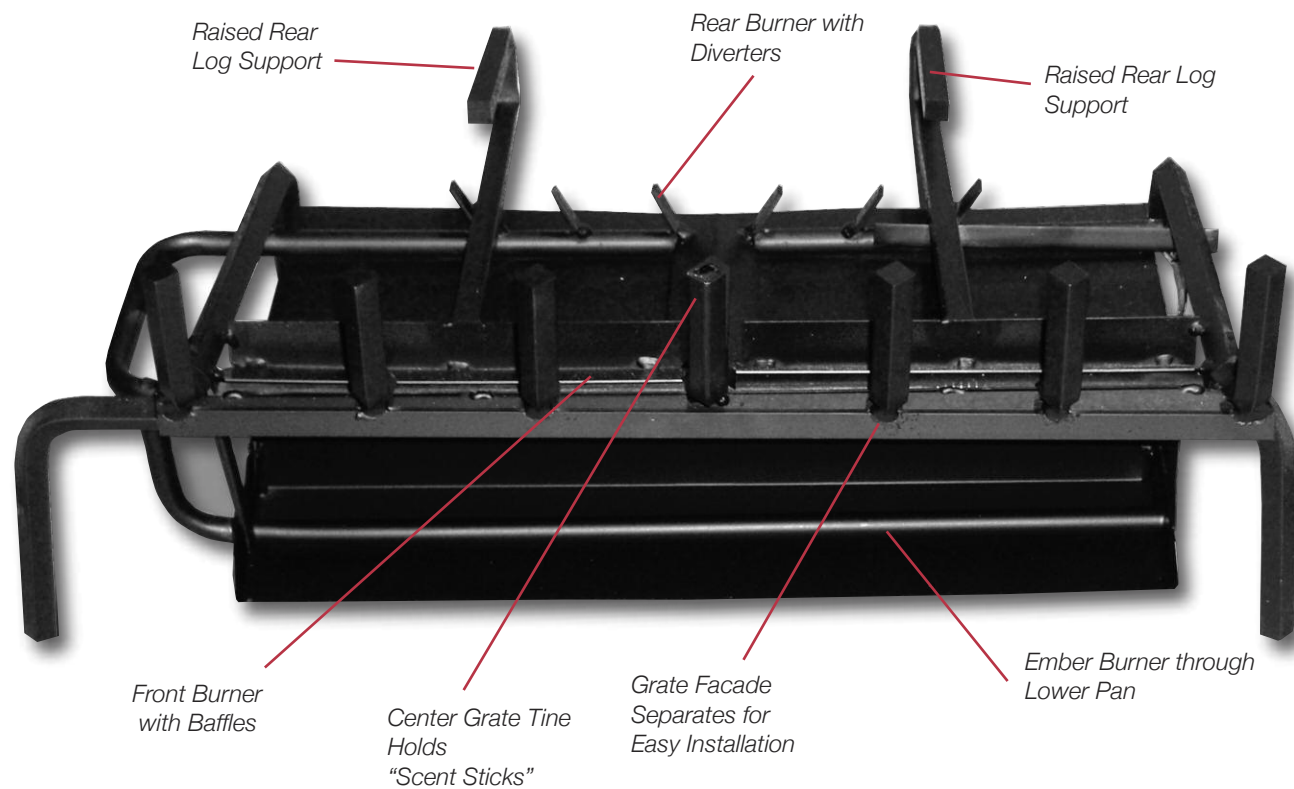

Master Flame™ Elite Triple Burner with Logs

The Elite Series is the preferred choice of those who want the fullest, most natural looking flame, and the only choice for those who want the luxury and esthetic appeal of a real wood fire. Optional conveniences like hi-lo flame modulation, remote controls and even electronic ignition give the owner the ultimate in comfort and mood control.

- Cleanest, most realistic burn in the industry
- Straight port injection
- Sandless - Specifically designed diverters and baffles disperse gas to provide a livelier, more natural-looking fire. No sand maintenance required.
- One piece burner construction
- Separate logs - can be configured to the owner's preference (number of logs depends on system size)
- Choice of Log Style
- High heat-resistant electrostatically applied, black finish
- Optional log accessory kit available to hide electronics, hook ups, etc.

Ordering Gas Log Burner and Logs

Specify Natural Gas (NG) or Propane Gas (LP) for each model ordered. Be sure to specify log style - Red Oak (RO), Charred Split Oak (CSO) Enchanted Evening (EE) or Aged Oak (AO) - along with the burner size. Examples: #EL24-NG-AO, #EL21-LP-CSO, #EL36-NG-RO

Log Styles Apply to ALL GAS LOG Models as noted in descriptions.

Optional: Specify Gas Control Valve Upgrade of installed gas valves.

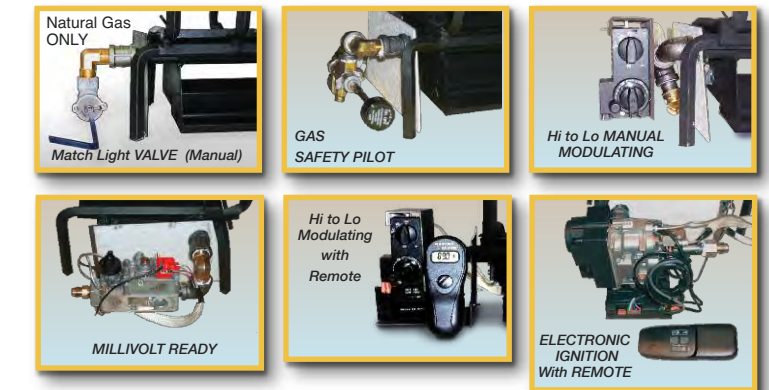

UPGRADE: Factory Installed Gas Valve

MANUAL VALVE MATCH LIGHT (NG ONLY)	MANUAL VALVE SAFETY PILOT (NG or LP)	MANUAL MODULATING VALVE KIT* (NG or LP)	MILLIVOLT READY VALVE KIT* (NG or LP)	Hi to Low MODULATING with REMOTE CONTROL	Hi to Low MODULATING REMOTE CONTROL and ELECTRONIC IGNITION* (NG or LP)
Add \$193	Add \$470	Add \$543	Add \$725	Add \$999	

UPGRADE KIT ONLY - Dealer Conversions

\$111	\$156	\$327	\$393	\$534	\$696
-------	-------	-------	-------	-------	-------



INSTALLATION KIT includes Black Lava Rock, Glowing Embers, Vermiculite Medium, Bendable Gas Line with Fittings and 10 Scent Sticks. Damper Clamp not supplied with Match-Lit Burner.

ELITE Burner with Log set	18" Burner (#EL18) MSRP	21" Burner (#EL21) MSRP	24" Burner (#EL24) MSRP	30" Burner (#EL30) MSRP
MATCH LIT	\$680	\$713	\$756	873
Log Style Choice	RO/CSO/AO	RO/CSO/AO	RO/CSO/AO	RO/CSO/AO
Burner ONLY	\$552	\$584	\$627	\$715
Weight of Burner:	35 lbs	40 lbs	45 lbs	50 lbs
Weight of Logs:	35 lbs	47 lbs	58 lbs	92 lbs

ALL Master Flame ELITE BURNERS and Gas Valves Factory Assembled and Bench Tested prior to shipment.

GAS LOG BURNERS

ELITE GEMINI "SEE-THRU" 5 BURNER With LOGS



The "SEE THRU" GEMINI Series features Master Flame's sandless, straight port injection providing the liveliest and most natural-looking flame and burn - noticeably superior to grate/burner/sand/pan log sets.

- Five Burners - Two Outside Burners, Center Burner and Twin Ember Burners (One on Each Side)
- High heat-resistant electrostatically applied, black finish
- Choice of Log Style (see page 4).
- Optional Gas Control Valve Upgrade (see page 2)

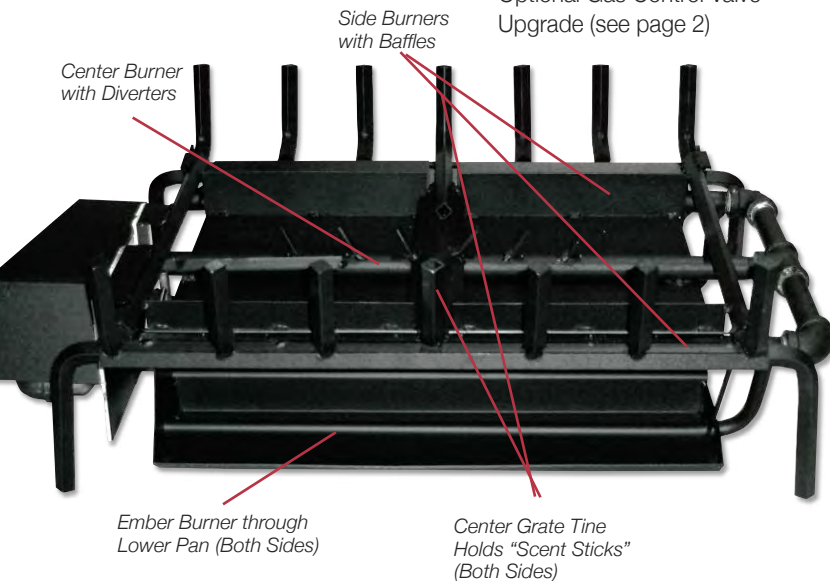

Specify NG or LP, Log Style and burner size.
Examples: #ELG18-NG-RO, #ELG24-LP-CSO
Optional Gas Control Valve UPGRADE (see page 14 for pricing and pictures of installed gas valves).

ELITE Gemini Burner with Log set	18" Burner (#ELG18) MSRP	21" Burner (#ELG21) MSRP	24" Burner (#ELG24) MSRP	30" Burner (#ELG30) MSRP
MATCH LIT	\$972	\$1004	\$1037	\$1169
Log Style Choice	RO/CSO/AO	RO/CSO/AO	RO/CSO/AO	RO/CSO/AO
Weight of Burner:	37 lbs	42 lbs	47 lbs	52 lbs
Weight of Logs:	35 lbs	47 lbs	58 lbs	92 lbs

PREMIUM SINGLE BURNER with LOGS

Get the flame and esthetic appeal of a real wood fire with the hand built Master Flame SAND BURNER Series Gas Log System. Separate steel grate allows optimum gas log placement for most efficient and natural looking flame. Available in 20", 24" or 30" burner sizes.



- Welded steel pan and burner tube
- Durable welded steel grate for gas logs
- Natural Gas only - Match Lit ONLY
- Electrostatically finished with high heat-resistant black paint
- Choice of Logset Style: Red Oak, Charred Split Oak or Aged Oak

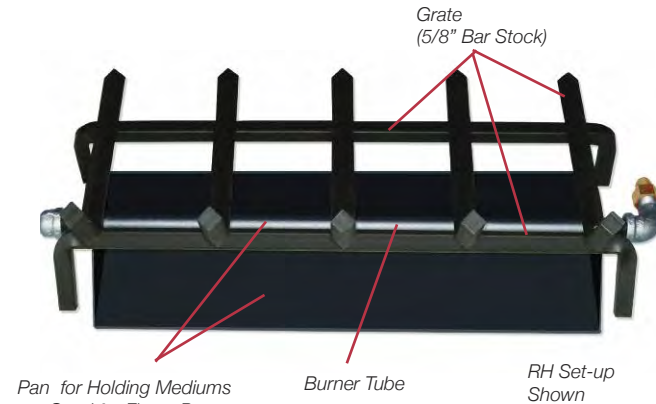

Match Lit Model - Natural Gas Only
Specify log style (see page 4) and burner size.
Example: #SB24-RO or #SB20-CSO

Single Burner with Log set	20" Burner (#SB20) MSRP	24" Burner (#SB24) MSRP	30" Burner (#SB30) MSRP
MATCH LIT	\$561	\$603	\$720
Log Style Choice	RO/CSO/AO	RO/CSO/AO	RO/CSO/AO
Burner ONLY	\$336	\$360	\$421

OUTDOOR GAS LOGS and LOG SETS

OUTDOOR 2 BURNER

100% Stainless Steel Dual Burner Outdoor



OUTDOOR DUAL Burners with Log set	Log Style	MATCH LIT (NG ONLY) MSRP
#ODSS-18"	CSO/RO/AO	\$759
#ODSS-21"	CSO/RO/AO	\$818
#ODSS-24"	CSO/RO/AO	\$877
#ODSS-30"	CSO/RO/AO	\$994

OUTDOOR SEE-THRU 3 BURNER



100% Stainless Steel Triple Burner Outdoor

OUTDOOR Triple Burner with Log set	Log Style	MATCH LIT (NG ONLY) MSRP
#ODSSST-18"	CSO/RO/AO	\$918
#ODSSST-21"	CSO/RO/AO	\$972
#ODSSST-24"	CSO/RO/AO	\$1040
#ODSSST-30"	CSO/RO/AO	\$1224

LOG KITS

For Master Flame Indoor and Outdoor Gas Log Burners

Red Oak Log Sets



RED OAK	SIZE Log Set	Logs in Set	MSRP
#RO18	18"	5	\$217
#RO21	21"	6	\$237
#RO24	24"	7	\$256
#RO30	30"	8	\$314

Charred Split Oak Log Sets



CHARRED SPLIT OAK	SIZE Log Set	Logs in Set	MSRP
#CSO18	18"	6*	\$217
#CSO21	21"	6*	\$237
#CSO24	24"	8*	\$314
#CSO30	30"	8*	\$365

* Front log is 2-piece

Aged Oak Log Sets



AGED OAK	SIZE Log Set	Logs in Set	MSRP
#AO18	18"	6	\$262
#AO21	21"	6	\$262
#AO24	24"	6	\$416
#AO30	30"	8	\$435

Black Touch-Up Paint



TOUCHUP STOVE PAINT	MSRP
#1990	\$13

For use on fireplace burners, fire pits and fire pit screens. 12 oz. spray can high temperature stove paint. NO DISCOUNT. Follow can instructions and warnings.

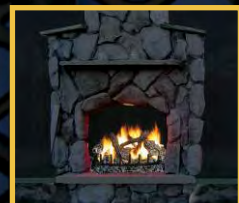

FIREPLACE GRATES

Standard FIREPLACE GRATES

Standard Welded Steel Grates

- Choice of 5/8" or 1/2" carbon steel bar stock or stainless steel bar stock
- Standard Fireplace Sizes 20", 24", 28" and 32" Width (Widest Part)
- 17" deep
- Char-Guard Ember Catch Option
- 4" legs for optimal air circulation (longer or shorter legs available for \$10 UPCHARGE)



FIREPLACE GRATE STANDARD SHAPE	20" (6 Bar/Tines) MSRP	24" (7 Bars/Tines)	28" (8 Bar/Tines)	32" (9 Bar/Tines)
5/8" CS	\$175	\$186	\$190	\$198
5/8" SS	\$340	\$409	\$435	\$487
1/2" CS	\$145	\$155	\$165	\$175
1/2" SS	\$245	\$265	\$285	\$310

CHAR-GUARD Ember Catch Option	20" Grate Adder to MSRP	24" Grate Adder to MSRP	28" Grate Adder to MSRP	32" Grate Adder to MSRP
UPCHARGE	\$11	\$21	\$32	\$43
Approx. Unit Weight 5/8" Bar	17 lbs.	20.4 lbs.	23.8 lbs.	27.2 lbs.
Approx. Unit Weight 1/2" Bar	15 lbs.	18 lbs.	21 lbs.	24 lbs.



RECTANGULAR FIREPLACE GRATES

Grate for See-Thru Fireplaces

FIRE PIT GRATE RECTANGULAR	TOTAL PERIMETER Up to 96" MSRP	TOTAL PERIMETER 97" to 144" MSRP	TOTAL PERIMETER 145-180" MSRP	TOTAL PERIMETER 181" + per inch ADDER Add to 180" MSRP
5/8" CARBON STEEL	\$214	\$265	\$417	\$15
5/8" STAINLESS STEEL	\$603	\$817	\$931	\$30
CHAR-GUARD Ember Catch Option	24" Grate Adder to MSRP	27" Grate Adder to MSRP	30" Grate Adder to MSRP	Over 38" Adder to MSRP
UPCHARGE	\$40	\$45	\$70	\$105

Approximate Unit Weight: 0.85 lb. per inch width

FIREPLACE SCREENS

Fireplace SAFETY SCREENS

Single Panel Fireplace Screen with Steel Footing or Bow (Curve)

- Aspen Industries Fireplace Screens are welded high grade steel mesh and bar stock and have a high heat-resistant electrostatically applied, black finish
- Handle(s) welded to top frame
- Maximum Size 48" x 48" (16 square feet)

How to Order Single Panel with Steel Footings

For single panel screen with steel footings, supply us with height and width and any footing requirement (Outside and Inside Feet). Standard size is 7" footings (Outside Feet stick out 4-3/4" in front and Inside Feet are 2-1/4" deep in back). Refer to figure at right.

How to Order Curved Single Panel (Bowed - No Leg Footings)

For curved screens, we require the height, width and curve depth (bow) required. Standard bow is 6". Welded handle available upon request.



SINGLE PANEL FIREPLACE SAFETY SCREEN STANDARD SIZES Flat or Curved (Bow)	STANDARD SIZE Up to 9 Square Feet MSRP
36 x 28"	\$245
36 x 30"	\$245
36 x 36"	\$245
40 x 28"	\$245
40 x 30"	\$245
40 x 36"	\$267
48 x 28"	\$267
48 x 30"	\$267
48 x 36"	\$311

SINGLE PANEL FIREPLACE SAFETY SCREEN CUSTOM SIZES	NON-STANDARD SIZES Up to 9 Square Feet MSRP	Over 9 Square Feet per square foot ADDER Add to STANDARD MSRP
FLAT with Frame Footing	\$245	\$22.00
CURVED (Bow)	\$245	\$22.00

DETERMINING NON-STANDARD SIZES: Multiply length X width and divide by 144 and round up. Example: 46 x 32" = 1472. 1472/144 = 11 square feet (10.2 square feet rounded up). Approximate Weight of Screens: 17 lbs.

CUSTOM FABRICATION

PRODUCT INDEX

WELDED STEEL PRODUCTS MADE TO SPECIFICATION:

Custom is referred to as any product not listed in the Aspen Industries, Inc. current price list.

To quote a Custom Unit Order we will need a drawing with specifications.

Aspen Industries Custom Order Department has manufactured many types of welded steel hearth, fireplace and fire pit product, including burners, fire grates, burner and grate systems, burner and pan system, "fire and ice" type burner / shallow pan, fireplace screens as well as unique fire pit screens with special handle and access locations.



PLASMA-CUT PLATE AND METAL SHEETING MADE TO SPECIFICATION:

To quote a Custom Part or Art Design Order we will need a drawing with specifications.

Aspen Industries Custom Order Department can fabricate parts and designs from sheet metal up to 1/2" plate. CALL FOR QUOTE.

CUSTOM Fire Pit Screens, Fire Pit Accessories, Fireplace Screens and Burners

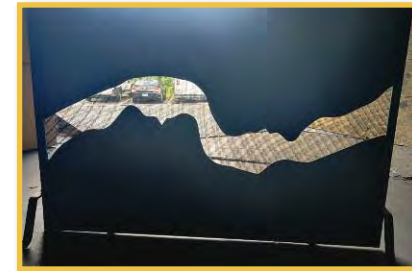
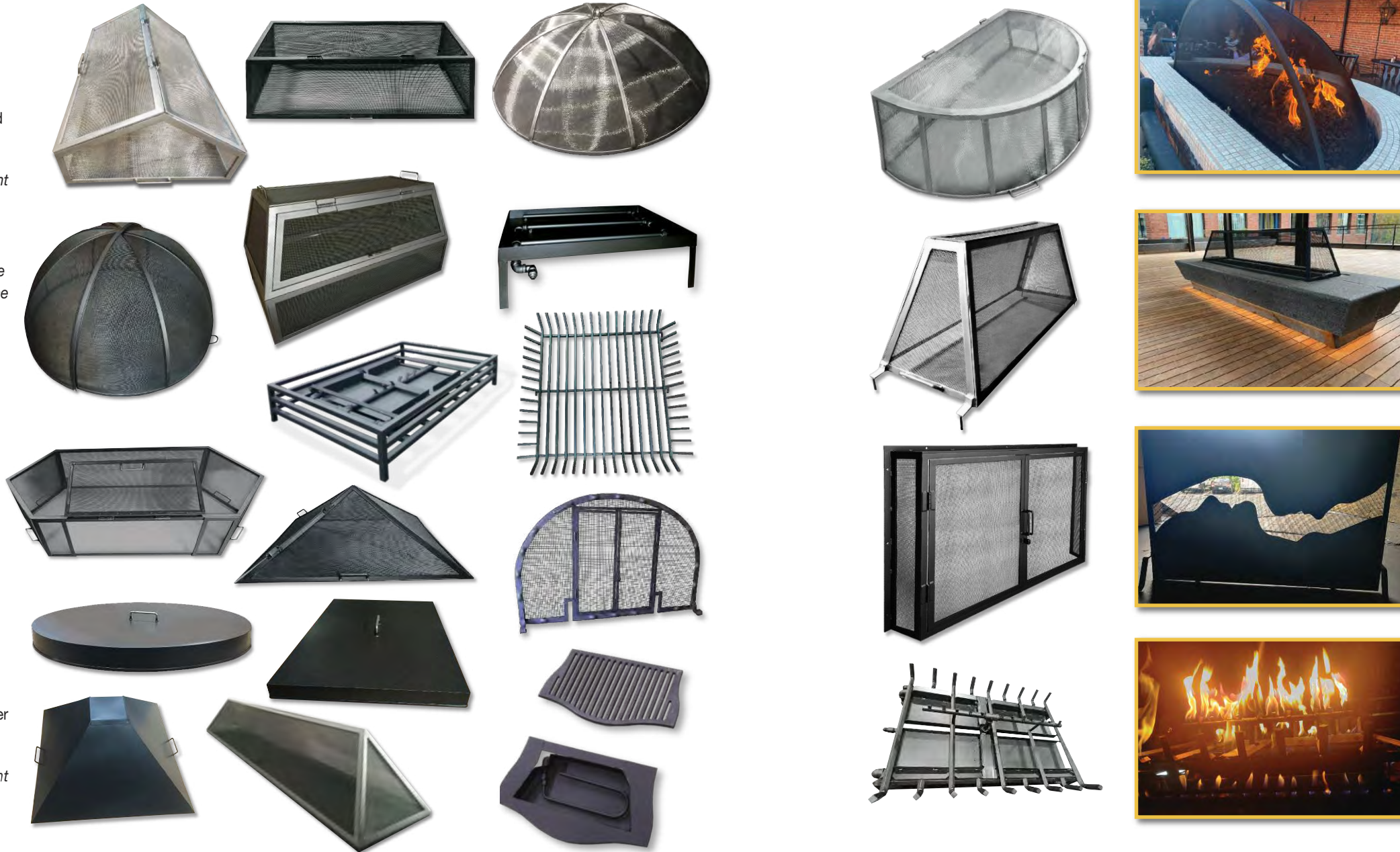

Master Flame Fire Pits and Accessories	
• Lift Off Dome Fire Pit Screens	1
• Round Hinged Fire Pit Screens	2
• Square and Rectangular Hinged Fire Pit Screens	3
• Square LOW PROFILE Hinged Fire Pit Screens	4
• Pivot Model Fire Pit Screens	5
• Fire Pit Grates	7
• Fire Pit Poker	8
• Fire Pit Covers and Snuffers	9
• Round Fire Bowl Welded Steel Fire Pits	11
• Custom Personalization for Lift Off and Pivot Fire Pit Screens	12
• Square / Rectangular Welded Steel Fire Pits	13
Gas Coal-Effect Burner System	
• Royal Coal Effect Burner System	14
Master Flame Gas Log Burner Systems and Logs	
• Elite Triple Burner with Logs	15
• Elite Gemini "See-Thru" 5 Burner with Logs	17
• Single Burner with Logs	17
• Outdoor Stainless Steel Two Burner with Logs	18
• Outdoor Stainless Steel Three Burner with Logs	18
• Log Kits	18
• High Heat Black Touchup Stove Paint	18
Fireplace Grates and Screens	
• Standard Fireplace Grate	19
• Rectangular Fireplace Grates	19
• Fireplace Screens	20
CUSTOM Welded Products	
• Custom Design Burners	21
• Custom Design Screens	21
• Custom Fire Pits	22
• Unique Designs and Parts	22
Warranties, Terms and Conditions	23

CUSTOM Metal Sheet / Plate Wall Art, Designs and Parts

